











83 030 892



- gauge 300 mm
- width 355mm
- height 55 mm
- rosette Ø 55 mm
- 80mm projection

| | | |
|------------------------------------------------------------------------------------|-------------------------------------|---------------|
|  | Brushed Chrome | 83 030 892-93 |
|  | Chrome | 83 030 892-00 |
|  | Brushed Platinum | 83 030 892-06 |
|  | Platinum | 83 030 892-08 |
|  | Dark Chrome | 83 030 892-19 |
|  | Brushed Durabrass (23kt Gold) | 83 030 892-28 |
|  | Matte Black | 83 030 892-33 |
|  | Brushed Champagne (22kt Gold) | 83 030 892-46 |
|  | Champagne (22kt Gold) | 83 030 892-47 |
|  | Brushed Dark Platinum | 83 030 892-99 |

83 030 892

mm [inches]



Certificates

TÜV_B0358530023_ TÜV_B0358530023_

Dt. EN.

83 030 892

Parts for other finishes can be found here: [Chrome](#)

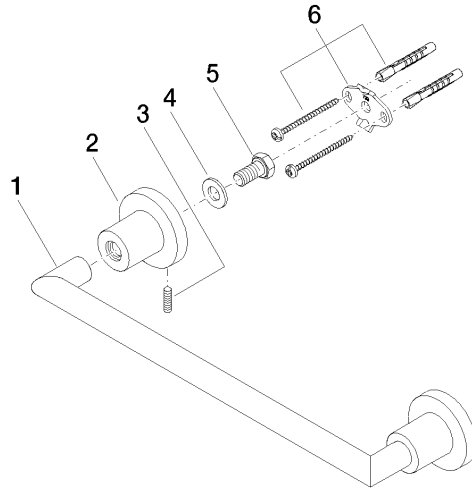

Spare parts list

| No. | Item Number | Name | Quantity used | Delivery time |
|-----|--------------------|------------|---------------|---------------|
| 1 | 05 28 22 587 00-93 | holder | 1 | 20 |
| 2 | 08 17 89 505-93 | holder | 2 | 20 |
| 3 | 04 31 11 113 00 90 | pin | 2 | 2 |
| 4 | 09 30 11 046 90 | disc | 2 | 2 |
| 5 | 09 30 30 071 90 | screw | 2 | 2 |
| 6 | 05 17 20 739 00 90 | fixing set | 2 | 2 |